

INSTRUCTIONS FOR USE

**ACTHAR® GEL [AK-thar jel]
(repository corticotropin injection)
for subcutaneous use only
Single-Dose Pre-filled SelfJect™ Injector**

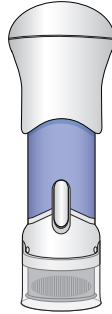

Purple Body Injector: 80 USP Units/mL of Acthar Gel

page left intentionally blank

Step 1: Read These Instructions

- **Carefully read, understand, and follow** this Instructions for Use before you use the Acthar Gel single-dose pre-filled SelfJect injector.
- Contact your healthcare provider if you are unsure of how to give the injection.

Important Information

- The Acthar Gel single-dose pre-filled SelfJect injector is for under the skin (subcutaneous) injection only.
- The Acthar Gel single-dose pre-filled SelfJect injector must only be given by adults 18 years of age and older.
- The Acthar Gel single-dose pre-filled SelfJect injector is a pre-filled injector for 1-time use only (single-dose).
- The Acthar Gel single-dose pre-filled SelfJect injector with the purple body should only be used to give a single dose of 80 units. Doses other than 80 units cannot be given with this Acthar Gel single-dose pre-filled SelfJect injector.
- This injector is **not an auto-injector**. The Handle must be pushed down by hand (see “The parts of the Acthar Gel single-dose pre-filled SelfJect injector” figure below).
- The injector has a Needle Guard to protect you and others from injury after it has been used.

The parts of the **Acthar Gel single-dose pre-filled SelfJect injector** are shown below:

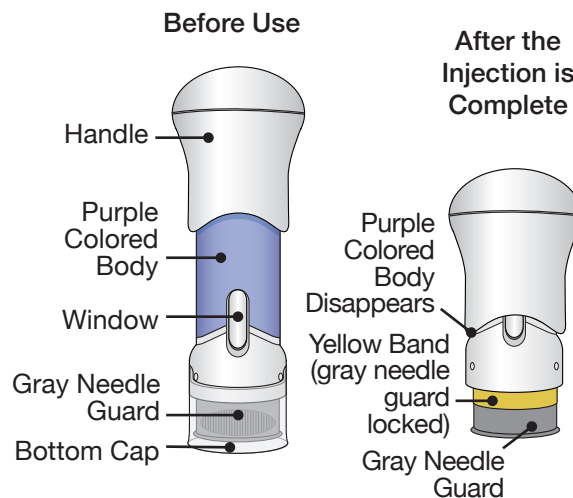

Storing Your Injector

- Store the Acthar Gel single-dose pre-filled SelfJect injector in the refrigerator between 36°F and 46°F (2°C and 8°C).
- Store the Acthar Gel single-dose pre-filled SelfJect injector in the original plastic tray to protect the injector from light.
- When it is time to use the Acthar Gel single-dose pre-filled SelfJect injector, take 1 injector from the refrigerator and return any unused injectors to the refrigerator.
- After removing the injector from the refrigerator, it can be stored at room temperature between 68°F and 77°F (20°C and 25°C) for up to **24 hours**.
- If the Acthar Gel single-dose pre-filled SelfJect injector has been left at room temperature for more than **24 hours**, contact Mallinckrodt: 1-800-778-7898.

- **Do not** heat the Acthar Gel single-dose pre-filled SelfJect injector.
- **Do not** freeze the Acthar Gel single-dose pre-filled SelfJect injector.
- **Do not** put the Acthar Gel single-dose pre-filled SelfJect injector into direct sunlight.
- **Keep the Acthar Gel single-dose pre-filled SelfJect injector and all medicines out of the reach of children.**

Step 2: Prepare to Use the Acthar Gel single-dose pre-filled SelfJect injector

- Choose a clean, well-lit room to give the injection.
- Take the injector tray out of the refrigerator.
- If the injector trays are in a multipack carton, take the injector tray out and return any unused injector trays to the refrigerator.
- **Do not** inject Acthar Gel right after removing it from the refrigerator. The injector **does not** work as well when cold.



- Check that you have the correct medicine and dose.
- Check the expiration date (EXP) on the package.

Do not use if the expiration date has passed.

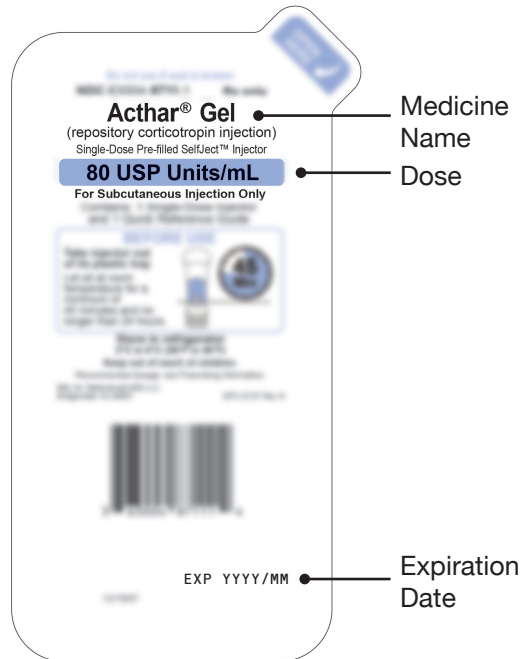

- Remove the injector from the injector tray and let it sit on a clean, dry, flat surface at room temperature to warm for a minimum of **45 minutes and no more than 24 hours** before use.

Do not heat the injector.

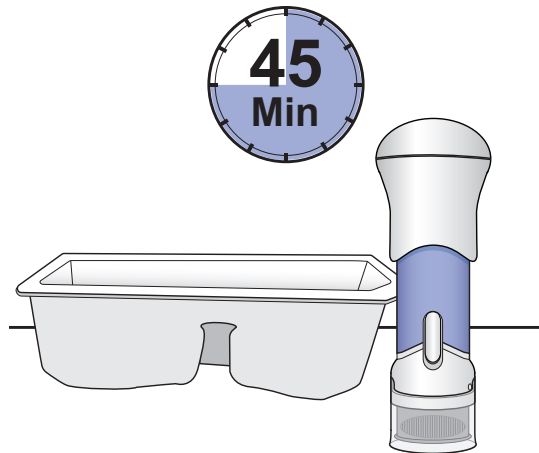

- Before use, the injector should look like this.
- The Bottom Cap should remain on the injector until you give the injection.

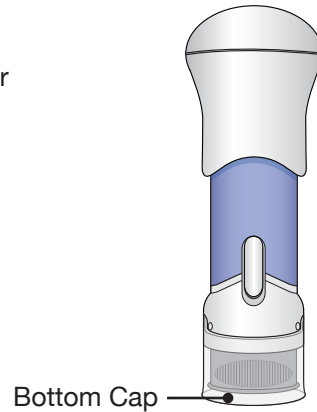

- **Do not** use the injector if the Bottom Cap is missing or not securely attached.
- If dropped, inspect the injector. **Do not** use if the injector is damaged or the Bottom Cap has come off.
- Gather an alcohol swab and sharps disposal container.
- You may also gather an adhesive bandage, gauze, or cotton ball to use after the injection to stop any bleeding.

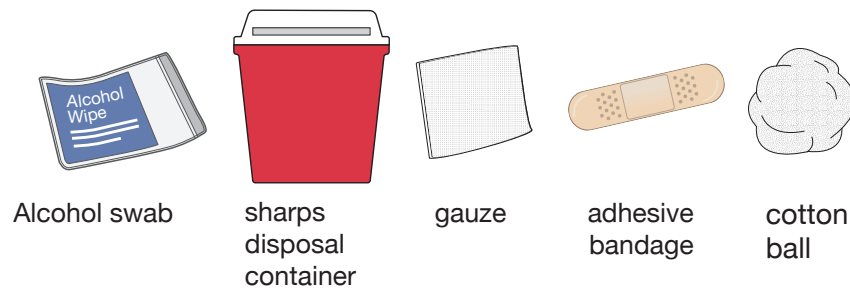

Step 3: Choose and Clean the Injection Site

- The Acthar Gel single-dose pre-filled SelfJect injector is for under the skin (subcutaneous) injection only.
- **Choose 1 of these sites for injection:**
 - Upper thigh
 - Belly (abdomen), not within 1-inch of belly button (navel)
 - Back of arm (only if someone else is giving the injection)
- Choose a different site for each injection. **Do not** use the same injection site more than 1 time each week.
- **Do not** inject through clothing.
- **Avoid injecting into:**
 - Irritated skin (red, swollen, or painful)
 - Tattoos
 - Warts
 - Scars
 - Birthmarks
 - Within 1-inch of the knee
 - Within 1-inch of the groin area
 - Stretch marks
- Wash your hands well with soap and water.

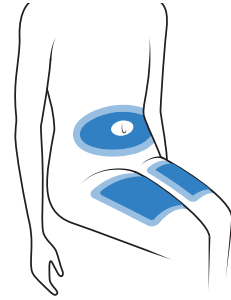

- Clean the injection site with an alcohol swab.
- **Do not** touch, fan, or blow on the injection site after you have cleaned it.

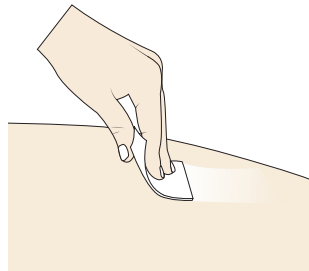

Step 4: Inspect and Uncap

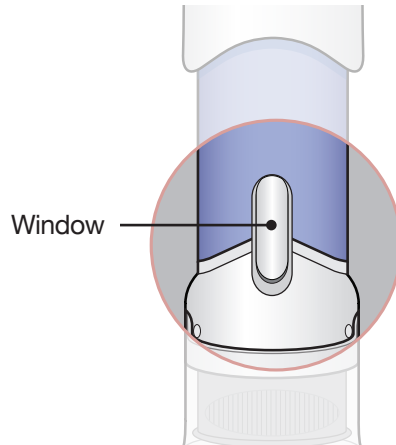

- **Make sure the injector has warmed at room temperature for a minimum of 45 minutes before you continue.**
 - Inspect the medicine in the Window.
 - If needed, wipe away any condensation (water collected) from the Window with a dry cloth.
 - Check the medicine in the Window. It should be a clear light yellow or orange solution.
 - **Do not use** if the medicine is cloudy or you see particles.
 - **Note:** It is normal to see air bubbles.
 - Pull the Bottom Cap off to remove it and throw it away in your household trash.
 - Avoid touching the Gray Needle Guard. The injector is now ready for use.
 - After the injector has been warmed for a minimum of 45 minutes and you have prepared the injection site, use the injector right away.
- Do not recap** the injector as this may damage the needle.

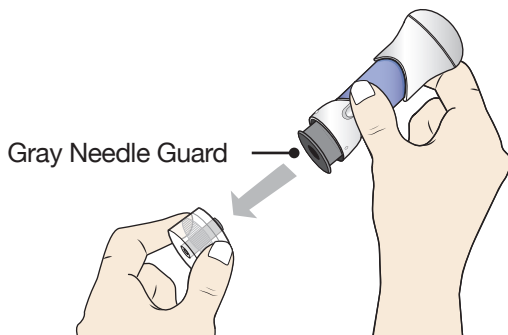

- When the Bottom Cap is removed, do not let the Gray Needle Guard touch any surface before injection.

Step 5: Inject

- Place the injector straight on the cleaned skin at a 90-degree angle.
Do not pinch the skin.

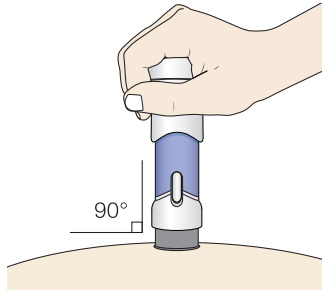

- Slowly push** the Handle down to inject the medicine.
Do not lift the injector during the injection. If you do, the injector will lock out and you will not get the full dose of medicine.
You may hear a “click” when the injection begins.

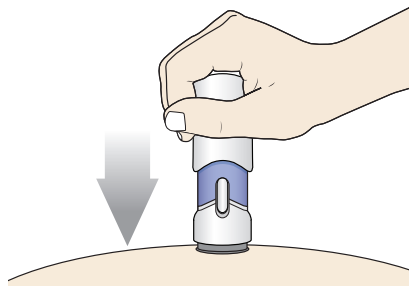

- The injection is complete when the Purple Colored Body disappears and you may hear a “click”.



Before you lift the injector up, check to make sure that no part of the Purple Colored Body remains visible. If you see color, continue pushing down on the Handle until the Purple Colored Body disappears completely.

Step 6: Lift

- Lift the injector straight up at a 90-degree angle off the injection site.
If the Yellow Band is visible, it means that the Needle Guard is locked. You cannot use the injector again.

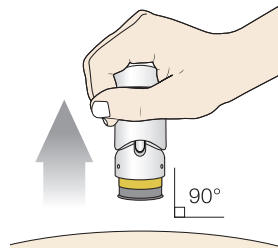

After the injection is complete, the injector should look like this:

After use, the injector should **not look like this**:

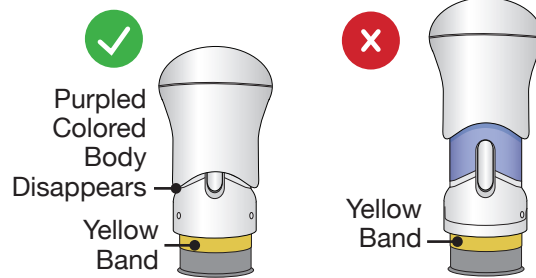

If you see the Purple Colored Body and the Yellow Band at the same time, then you did not give the full dose.

Do not try to inject with this injector again. **Do not** use another injector. Contact your healthcare provider.

- If there is any bleeding at the injection site, cover the site with an adhesive bandage, a cotton ball, or a gauze. Apply gentle pressure until the bleeding stops.

Step 7: Throw Away (Dispose of) your Used Acthar Gel single-dose pre-filled SelfJect injector

- Put your used Acthar Gel single-dose pre-filled SelfJect injector in an FDA-cleared sharps disposal container right away after use.

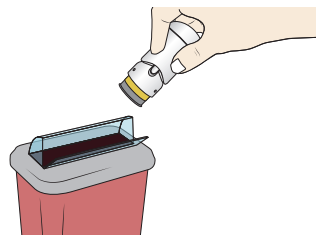

- Do not** throw away your injector in your household trash.
- If you do not have an FDA-cleared sharps disposal container, you may use a household container that is:
 - o made of a heavy-duty plastic,
 - o can be closed with a tight-fitting, puncture-resistant lid, without sharps being able to come out,
 - o upright and stable during use,
 - o leak-resistant, and
 - o properly labelled to warn of hazardous waste inside the container.

- When your sharps disposal container is almost full, you will need to follow your community guidelines for the right way to dispose of your sharps disposal container. There may be state or local laws about how you should throw away used needles and syringes. For more information about safe sharps disposal, and for specific information about sharps disposal in the state that you live in, go to the FDA's website at: <http://www.fda.gov/safesharpsdisposal>
- Do not dispose of your used sharps disposal container in your household trash unless your community guidelines permit this.
- Do not recycle your used sharps disposal container.

Manufactured for:
Mallinckrodt ARD LLC
Bridgewater, NJ 08807

SPC-0205 Rev 7
US-2400166

This Instructions for Use has been approved by the U.S. Food and Drug Administration.

Approved: 02/2024



127009